

Store or display your products on our durable platters and in our durable lugs.

5000024



5000025



5000026



5000027



5000031



5000079
(Lid for 5000031)



FEATURES

- Injection molded polystyrene with reinforced front and side edges for added strength
- Ideal for use in production settings as well as product display
- Fits all standard platter racks and lug carts
- Light weight and durable construction
- Nesting and cross stacking
- Easy to clean - smooth surfaces

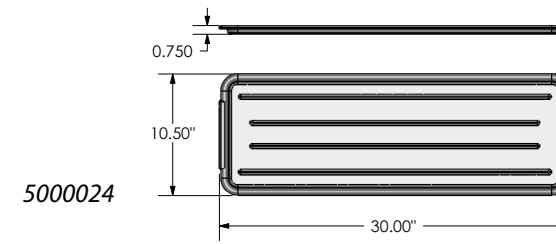
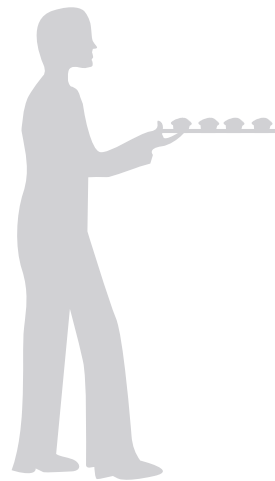

5000024

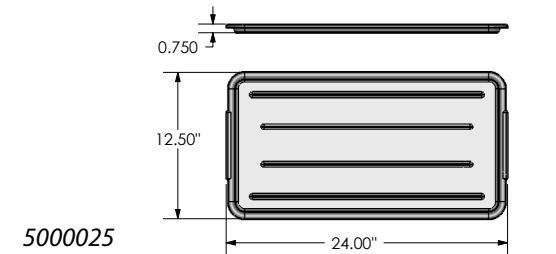

5000025

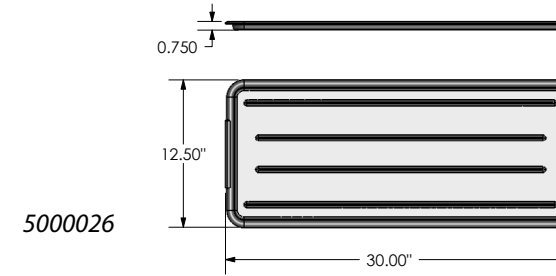

5000026

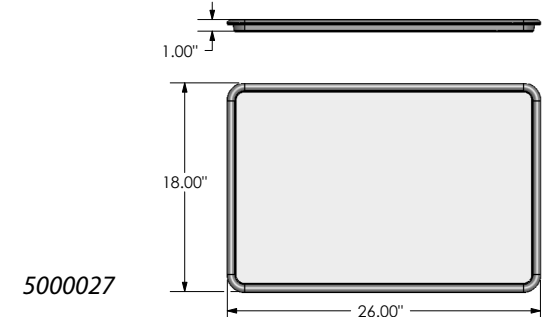

5000027

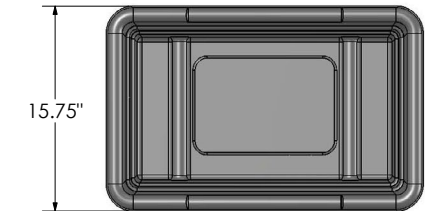

5000031

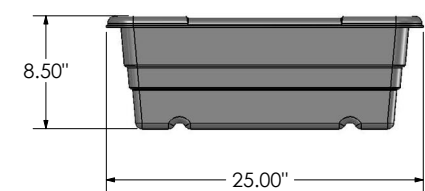

5000079

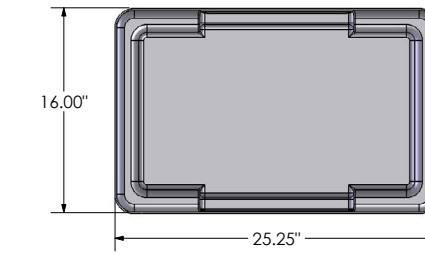

Order #	Model	Description	Color	W	L	D
5000024	P-1030, PLASTIC MEAT PLATTERS, WHT	Meat Platter	White	10 1/2"	30"	3/4"
5000025	P-1224, PLASTIC MEAT PLATTERS, WHT	Meat Platter	White	12 1/2"	24"	3/4"
5000026	P-1230, PLASTIC MEAT PLATTERS, WHT	Meat Platter	White	12 1/2"	30"	3/4"
5000027	P-1826, PLASTIC MEAT PLATTERS, WHT	Meat Platter	White	18"	26"	1"
5000031	SNL-8, GREY PLASTIC LUG	Product Lug	Gray	16"	26 1/2"	8"
5000079	SNL-8-C, LUG LID, GRAY	Lug Lid	Gray	16"	26 1/2"	8"

Meat Platters
Freight Class: 85
NMFC Code: 175180-S2

Lug and Lid
Freight Class: 100
NMFC Code: 156600-S6

Can't find exactly what you need? Give us a call and we'll help you with the perfect solution!